



Outdoor PTZ Camera Hardware Manual

KCM-8211

2013/05/09



ACTi
Connecting Vision

Table of Contents

Precautions	3
--------------------------	----------

Introduction	4
---------------------------	----------

List of Models.....	4
Package Contents.....	5
Safety Instructions	6
Physical Description	7

Installation	9
---------------------------	----------

Step 1: Unpack the Camera	9
Step 2: Mount the Camera	11
Mounting Options.....	11
Other Mounting Accessories	12
How to Mount the Outdoor PTZ	13
Step 3: Connect the Equipment.....	14
How to View the Camera on Your PC	14
How to Connect Digital Input / Digital Output Devices	14

Accessing the Camera	18
-----------------------------------	-----------

Configure the IP Addresses.....	18
Access the Camera.....	22

Precautions

Read these instructions

You should read all the safety and operating instructions before using this product.

Heed all warnings

You must adhere to all the warnings on the product and in the instruction manual. Failure to follow the safety instructions given may directly endanger people, cause damage to the system or to other equipment.

Servicing

Do not attempt to service this video device yourself as opening or removing covers may expose you to dangerous voltage or other hazards. Refer all servicing to qualified service personnel.

Trademarks

All names used in this manual are probably registered trademarks of respective companies.

Liability

Every reasonable care has been taken during the writing of this manual. Please inform your local office if you find any inaccuracies or omissions. We cannot be held responsible for any typographical or technical errors and reserve the right to make changes to the product and manuals without prior notice.

FCC/CE Regulation

Note: This equipment has been tested and found to comply with the limits for a Class B digital device, pursuant to Part 15 of the FCC Rules. These limits are designed to provide reasonable protection against harmful interference when the equipment is operated in a commercial environment. This equipment generates, uses, and can radiate radio frequency energy and, if not installed and used in accordance with the instruction manual, may cause harmful interference to radio communications. Operation of this equipment in a residential area is likely to cause harmful interference in which case the users will be required to correct the interference at their own expense.

Introduction

List of Models

This hardware manual contains the following model:

KCM-8211		2MP Outdoor PTZ Camera with D/N, Advanced WDR, SLLS, 18x Zoom lens
----------	---	--

Package Contents

1. Camera



KCM-8211

2. Power Cord



3. Power Adaptor



4. Allen Wrench



5. Screws



6. Quick Installation Guide

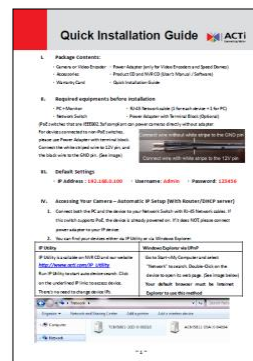

7. Warranty Policy

ACTI Hardware Warranty Policy

Product Category	Warranty Period	3 Years	2 Years	1 Year	6 Months
Webcams	6 Months				
Audio Devices	6 Months				
Headsets	6 Months				
Microphones	6 Months				
IP Cameras	3 Years				
IP Cameras	3 Years				
IP Cameras	3 Years				
IP Cameras	3 Years				
Video Encoder	3 Years				
Video Encoder	3 Years				
Video Encoder	3 Years				
Encoder	3 Years				
Encoder	3 Years				
Encoder	3 Years				

ACTI Hardware Warranty Policy

ACTI Connect (ACTI) products are warranted to be free from defects in material and workmanship under normal use within the warranty period.

Products not sold through ACTI Authorized Distributors are not covered in the warranty agreement. Warranty obligations for reseller products are governed by separate contracts and not covered in this document.

Safety Instructions

Cleaning

Disconnect this video product from the power supply before cleaning.

Attachments

Do not use attachments not recommended by the video product manufacturer as they may cause hazards.

Do not use accessories not recommended by the manufacturer

Only install this device in a dry place protected from weather.

Servicing

Do not attempt to service this video product yourself. Refer all servicing to qualified service personnel.

Damage Requiring service

Disconnect this video product from the power supply immediately and refer servicing to qualified service personnel under the following conditions:

- 1) When the power-supply cord or plug is damaged.
- 2) If liquid has been spilled or objects have fallen into the video product.
- 3) If the inner parts of the video product have been directly exposed to rain or water.
- 4) If the video product does not operate normally by following the operating instructions in this manual. Adjust only those controls that are covered by the instruction manual, as an improper adjustment of other controls may result in damage, and will often require extensive work by a qualified technician to restore the video product to its normal operation.

Safety Check

Upon completion of any service or repairs to this video product, ask the service technician to perform safety checks to determine if the video product is in proper operating condition.

Physical Description



1) Audio Output

This jack connects to an audio output device, such as a speaker.

2) DC 12V Power Input

This jack connects to the power adaptor and power cord to supply power to the camera.

3) Audio Input

This jack connects to an audio input device, such as a microphone with built-in amplifier.

Note: Make sure that the connected audio input device has a built-in amplifier. Connecting an ordinary microphone will dwarf sounds and will result in inaudible recording.

4) Ethernet Port

The Ethernet port connects to a network using a standard Ethernet cable.

5) Digital Input / Output

The colored cables connect to digital input or output devices, such as an alarm trigger, panic button, etc. Digital Input (DI) and Digital Output (DO) devices are used for applications like motion detection, event triggering, alarm notifications, etc. Please refer to [How to Connect Digital Input / Digital Output Devices on page 14](#) for information on how to connect DI/DO devices to your camera.

6) Power Button

The power button is used to restart the camera. In case there is a need to restart the camera, press the power button (using a pointed object, such as a pen or pin).

7) Power LED

The Power LED lights red when the camera is powered up.

8) Reset Button

The reset button is used to restore the factory default settings of the camera, including the administrator's password.

The reset button can be used for following purposes:

1. The administrator's password has been forgotten and therefore the camera cannot be accessed.
2. In case of IP address, mask, or allow/deny filter related issues, resulting with inability to modify these settings.
3. In case of connectivity issues or abnormal video quality.

How to do the reset properly?

Step 1: Disconnect the power supply (e.g. disconnect the power adaptor or the high PoE injector).

Step 2: Press and continue to hold the reset button (using a pin).

Step 3: Connect the power supply while keeping the reset button pressed.

Step 4: Wait for 45 seconds and release the reset button.

Installation

Step 1: Unpack the Camera

1. Remove the plastic cover.



2. Loosen the four screws using the allen wrench.

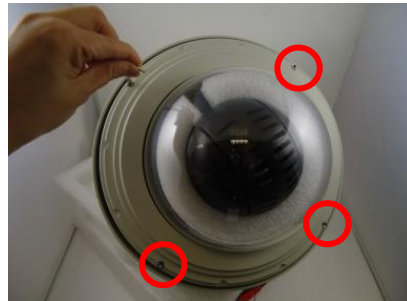

3. Carefully lift the camera cover and place it aside.

Note: The cover is attached to the camera by a metallic wire; do not abruptly lift the cover.



4. Remove the styrofoam.



Outer Styrofoam



Inner Styrofoam



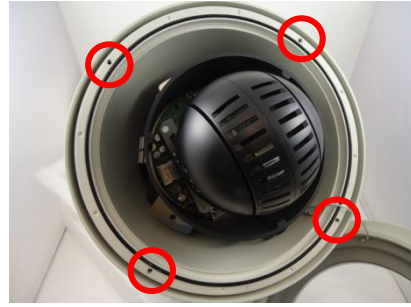

5. Attach the camera cover.
Align the cover screws to the screw holes on the camera (as marked on the illustration) and secure the screws using the allen wrench.













Step 2: Mount the Camera



Mounting Options

There are several mounting options that you can use to install the Outdoor PTZ camera. For more information about mounting solutions and accessories, please refer to the Buyer's Guide.

Mount Types	Accessories	
Pendant Mount	Suitable when mounting the Outdoor PTZ on a hard ceiling.	
	PMAX-0102 (Straight Tube w/o Bracket)	
	PAMX-0103 (Straight Tube with Bracket)	
Straight Wall Mount	Suitable when mounting the Outdoor PTZ on a straight wall.	
	PMAX-0305 (Heavy Duty Wall Mount)	
	PMAX-0302 (Gooseneck with Bracket)	
	PMAX-0303 (Gooseneck without Bracket)	

Vertical Pole Mount	Suitable when mounting the Outdoor PTZ on a vertical pole.	
	PAMX-0303 	PMAX-0503 
	PAMX-0305 	PMAX-0503 
Horizontal Pole Mount	Suitable when mounting the Outdoor PTZ on a horizontal pole.	
	PAMX-0102 	PMAX-0503 
Corner Mount	Suitable when mounting the Outdoor PTZ on a corner wall.	
	PAMX-0303 	PAMX-0402 
	PAMX-0305 	PAMX-0402 

Other Mounting Accessories

Accessories	
PMAX-0700 (Junction Box) 	PAMX-0104 (Extension Tubes) 

How to Mount the Outdoor PTZ

1. Install the mounting solution

Please refer to the installation guide that came with the mounting solution.

2. Insert the cable

Insert the camera cables through the mounting tube (e.g. gooseneck, heavy wall mount, straight tube, extension tube, etc.) and through a hole in the wall or ceiling.

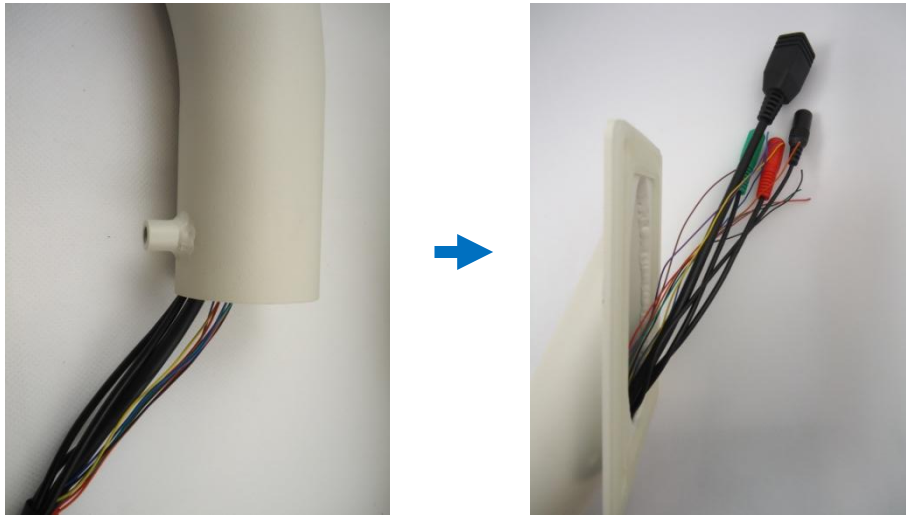

CAUTION: The camera itself is waterproof, however take note that the cable connections are not. If the cable connections will be exposed outdoors, make sure to shield or adapt proper waterproofing methods.

DISCLAIMER: ACTi will not be responsible for camera damage caused by water entering the cable connections.

3. Mount the camera

1. Insert the top of the camera through the mounting tube.

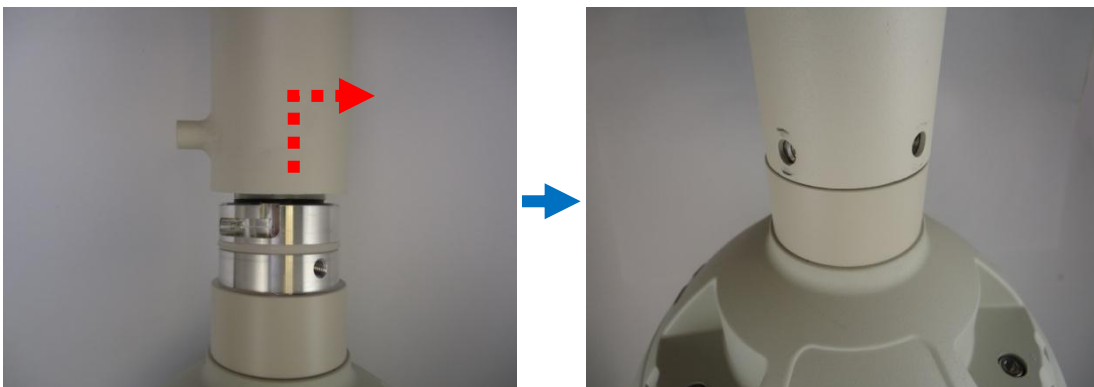

2. Secure the camera with screws.

Step 3: Connect the Equipment

How to View the Camera on Your PC

Perform the following connections to view the camera from your PC:

1. Connect the camera and the PC to the same network using Ethernet cables.
2. Connect the camera to a power supply using the supplied power adaptor and power cord.

The Power LED of the camera will flash a few times and turn off as the camera mechanical components initialize. Wait for the initialization to complete. Once complete, the Power LED will light red to indicate the camera works normally.

Note: Use only the supplied power adaptor and power cord that came with the camera or the optional High PoE Injector (PPOE-0110). Using other accessories not approved by the manufacturer may cause damage to the equipment.

How to Connect Digital Input / Digital Output Devices

Depending on your surveillance needs, you may connect digital input or output devices to your camera to trigger events or notifications.

Digital Input (DI) devices can be used to notify the camera about an activity in the camera site. DI can be triggers of events. For example, you can connect a “panic button” to the camera; as such when the panic button is pressed, the alarm signal will be sent through the camera. Other common DI device applications are emergency button, smoke detector, passive infrared sensor, etc.

Digital Output (DO) devices are external devices that are activated by the camera upon an event inside the camera. For example, you can connect an “alarm horn” to the camera; as such when an event occurs inside the camera (e.g. detected intruder), the alarm horn will sound. Other common DO device applications are motion-triggered lights, electric fence, magnetic door locks, etc.

Understanding the DI/DO Cables

You can connect up to two DI and two DO devices to your camera.

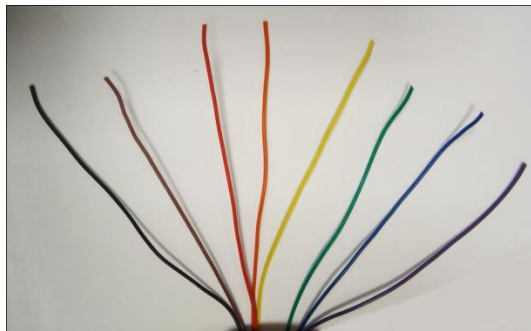

Device	Cable Color	Connection
Digital Input 1 (DI1)	Black	Ground (GND)
	Red	Digital Input 1 (DI1)
Digital Input 2 (DI2)	Yellow	Ground (GND)
	Blue	Digital Input 2 (DI2)
Digital Output 1 (DO1)	Brown	12V DC
	Orange	Digital Output 1 (DO1)
Digital Output 2 (DO2)	Green	12V DC
	Purple	Digital Output 2 (DO2)

The table below shows the DI/DO connection specifications:

Device			
DI	Connection design		TTL - compatible logic levels
	Voltage	To trigger (low)	Logic level 0: 0V ~ 0.4V
		Normal (high)	Logic level 1: 3.1V ~ 30V
	Current		10mA ~ 100mA
DO	Connection design		Transistor (Open Collector)
	Voltage & Current		< 24V DC, < 100mA

Typical Connection

Based on these specifications, if the DI device has a voltage of 0V ~ 30V or the DO device has a voltage of < 24V (<100mA), then the camera can supply internal power to these devices and there is no need to connect the DI/DO device to an external power source.

In this case, use the Black (GND) and the Red (DI1) cables to connect a DI device and use the Brown (12V) and the Orange (DO1) cables to connect a DO device. See wiring scheme below:

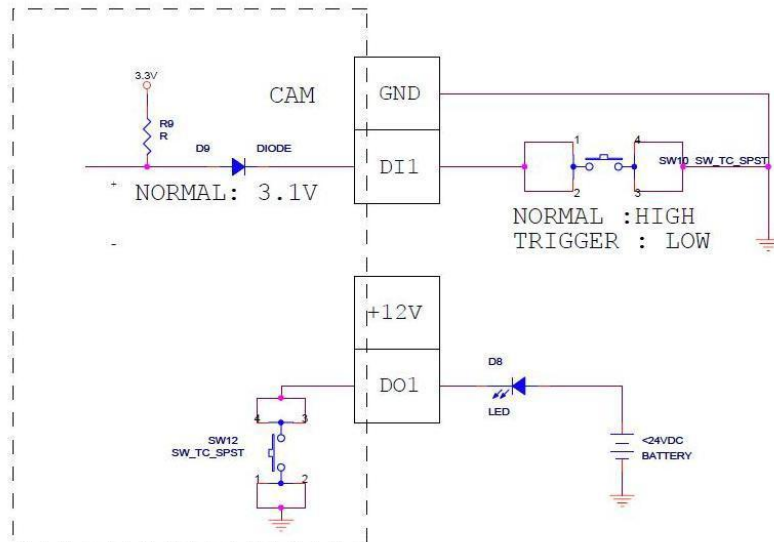

Consequently, to connect a second DI or DO device, use the Yellow (GND) and Blue (DI2) cables to connect the second DI device, and the Green (12V) and Purple (DO2) cables for the second DO device.

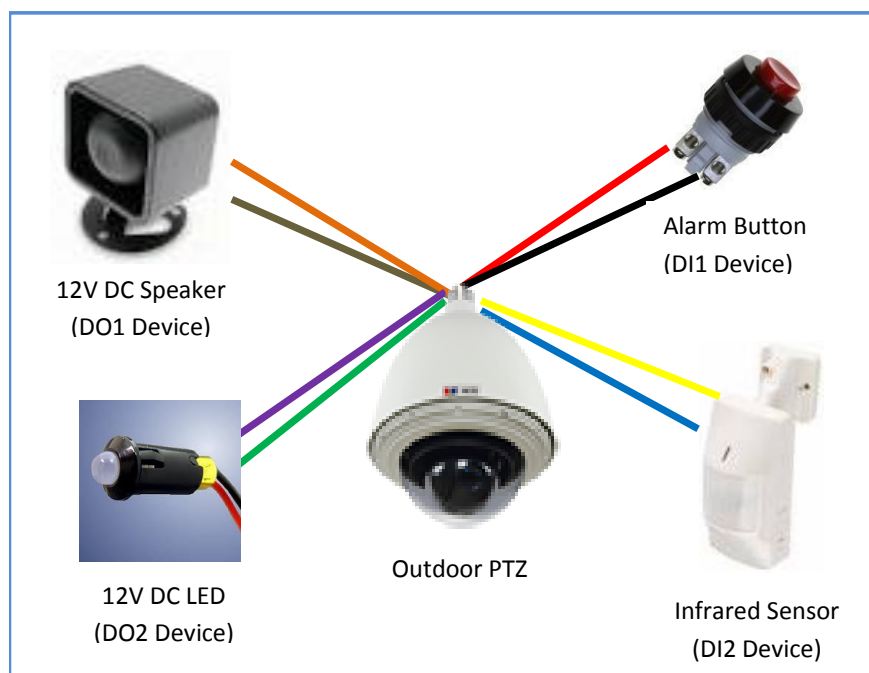

High Voltage DO Device Connection

Even though the camera provides 12V power, this may not be enough for some high voltage DO devices, such as a ceiling light or a motor that opens or closes a gate. In this case, there is a need to connect an external relay. See wiring scheme below:

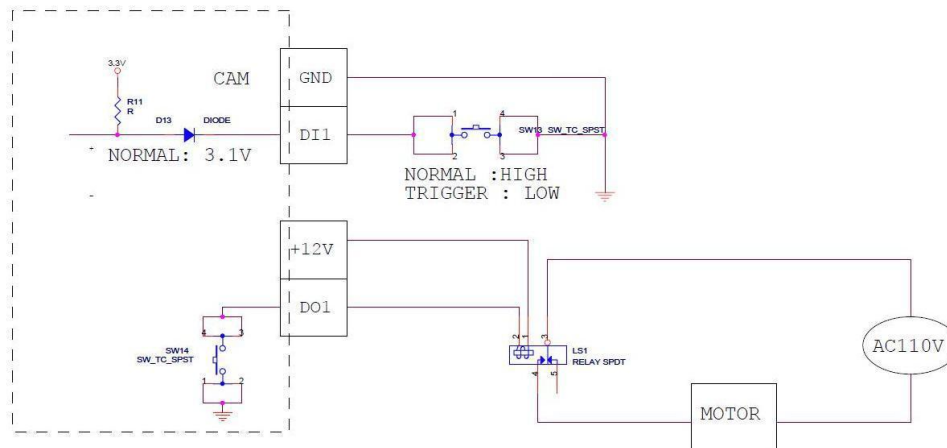

Note that when choosing an appropriate relay, please refer to its specifications and make sure they match the above design. The triggering circuit voltage has to be around 12V DC and the switch-controlled circuit voltage has to match the external power supply (e.g. 110V AC or 220V AC).

The illustration below is a graphic example of connecting a relay to a high voltage DO device.

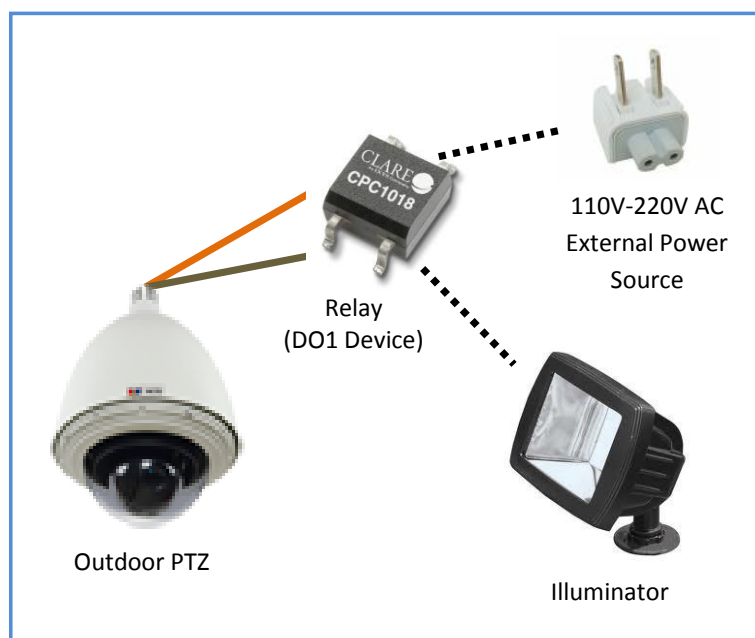

Note: For more information on DI/DO connections, please refer to the article [All about Digital Input and Digital Output](http://www.acti.com/kb/detail.asp?KB_ID=KB20091230001) (http://www.acti.com/kb/detail.asp?KB_ID=KB20091230001) in the Knowledge Base section of our website (www.acti.com).

Accessing the Camera

Configure the IP Addresses

In order to be able to communicate with the camera from your PC, both the camera and the PC have to be within the same network segment. In most cases, it means that they both should have very similar IP addresses, where only the last number of the IP address is different from each other. There are 2 different approaches to IP Address management in Local Area Networks – by DHCP Server or Manually.

Using DHCP server to assign IP addresses

If you have connected the computer and the camera into the network that has a DHCP server running, then you do not need to configure the IP addresses at all – both the camera and the PC would request a unique IP address from the DHCP server automatically. In such case, the camera will immediately be ready for the access from the PC. The user, however, might not know the IP address of the camera yet. It is necessary to know the IP address of the camera in order to access it using a Web browser.

The quickest way to discover the cameras in the network is to use the simplest network search, built in the Windows system – just by pressing the “Network” icon, all the cameras of the local area network will be discovered by Windows, thanks to the UPnP function support of our cameras.

In the example below, the **KCM-8211** camera that has just been connected to the network is successfully found.

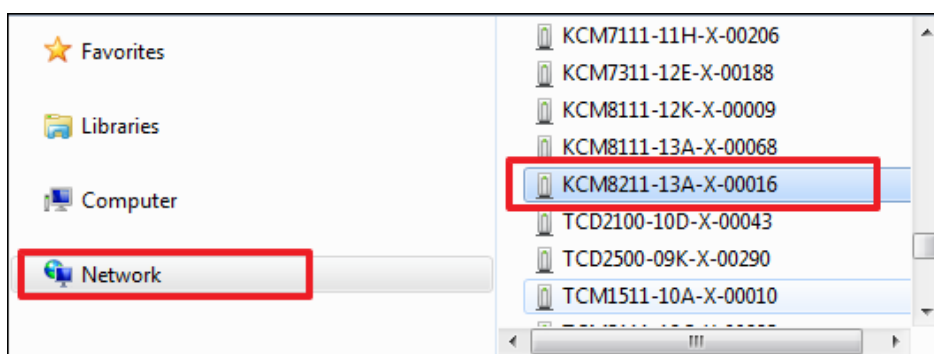

When the left mouse is clicked on **KCM-8211**, the default browser of the PC is automatically launched and the IP address of the target camera is already filled in the address bar of the browser.

If you work with our cameras regularly, then **there is even a better way to discover the cameras in the network** – by using **IP Utility**. The IP Utility is a light software tool that can not only discover the cameras, but also list lots of valuable information, such as IP and MAC addresses, serial numbers, firmware versions, etc, and allows quick configuration of multiple devices at the same time.

The IP Utility can be downloaded for free from http://www.acti.com/IP_Utility

When you launch IP Utility, the list of connected cameras in the network will be shown. See sample illustration below:

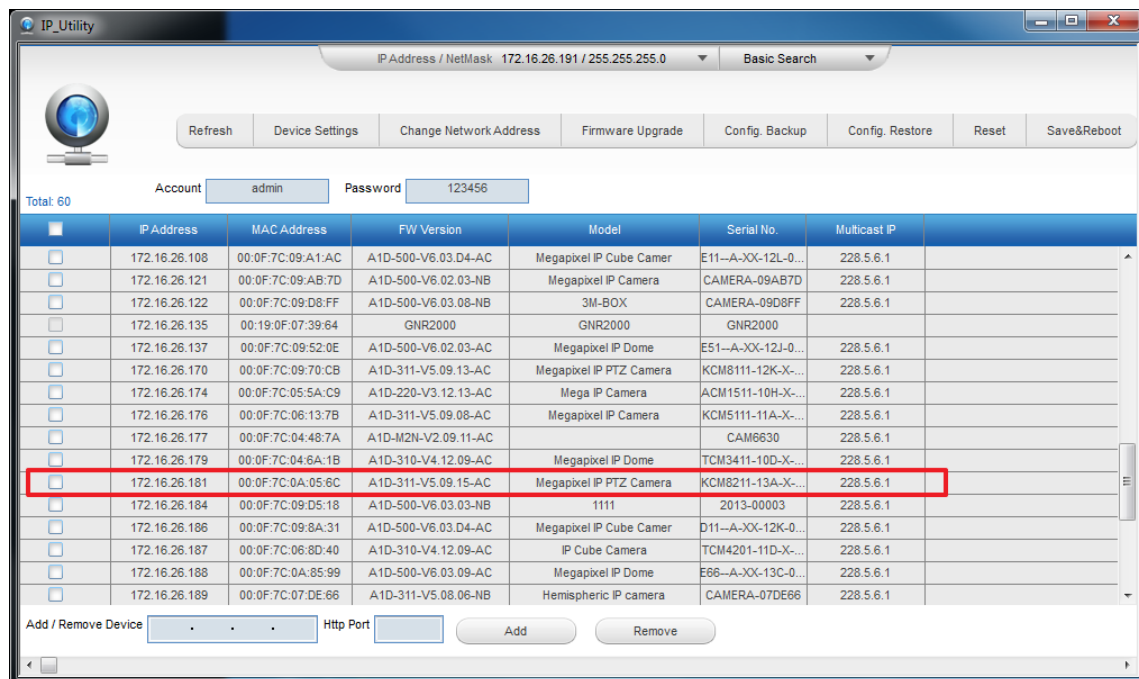

You can quickly notice the **KCM-8211** model in the list. Click on the IP address to automatically launch the default browser of the PC with the IP address of the target camera already filled in the address bar of the browser.

Use the default IP address of the camera

If there is no DHCP server in the given network, the user may have to manually assign the IP addresses to both the PC and the camera to make sure they are in the same network segment.

When the camera is plugged into the network and it does not detect any DHCP services, it will automatically assign itself a default IP:

192.168.0.100

Whereas the default port number would be **80**. In order to access that camera, the IP address of the PC has to be configured to match the network segment of the camera.

Manually adjust the IP address of the PC

In the following example, based on Windows 7, we will configure the IP address to **192.168.0.99** and set Subnet Mask to **255.255.255.0** by using the steps below:

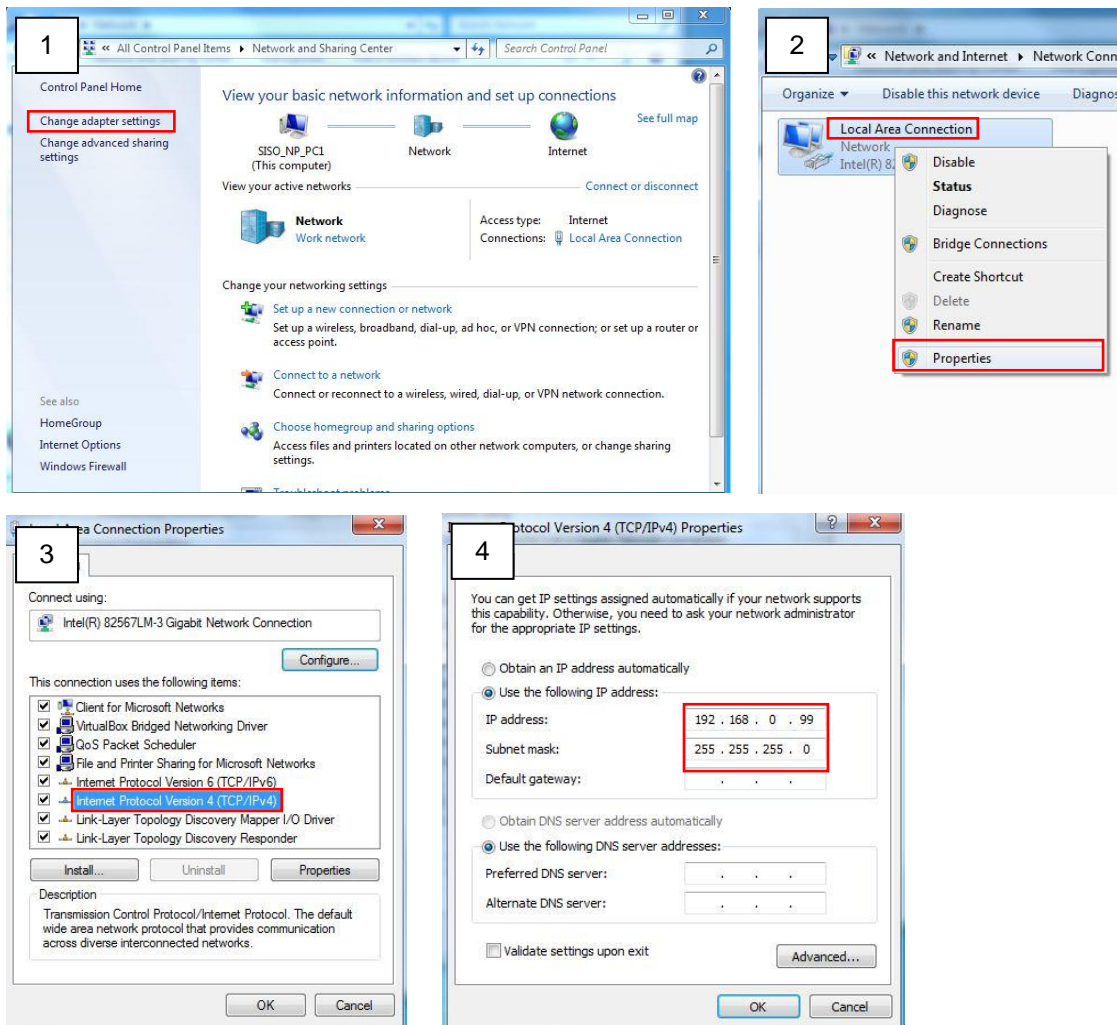

Manually adjust the IP addresses of multiple cameras

If there are more than one camera to be used in the same local area network and there is no DHCP server to assign unique IP addresses to each of them, all of the cameras would then have the initial IP address of **192.168.0.100**, which is not a proper situation for network devices – all the IP addresses have to be different from each other. The easiest way to assign cameras the IP addresses is by using **IP Utility**:

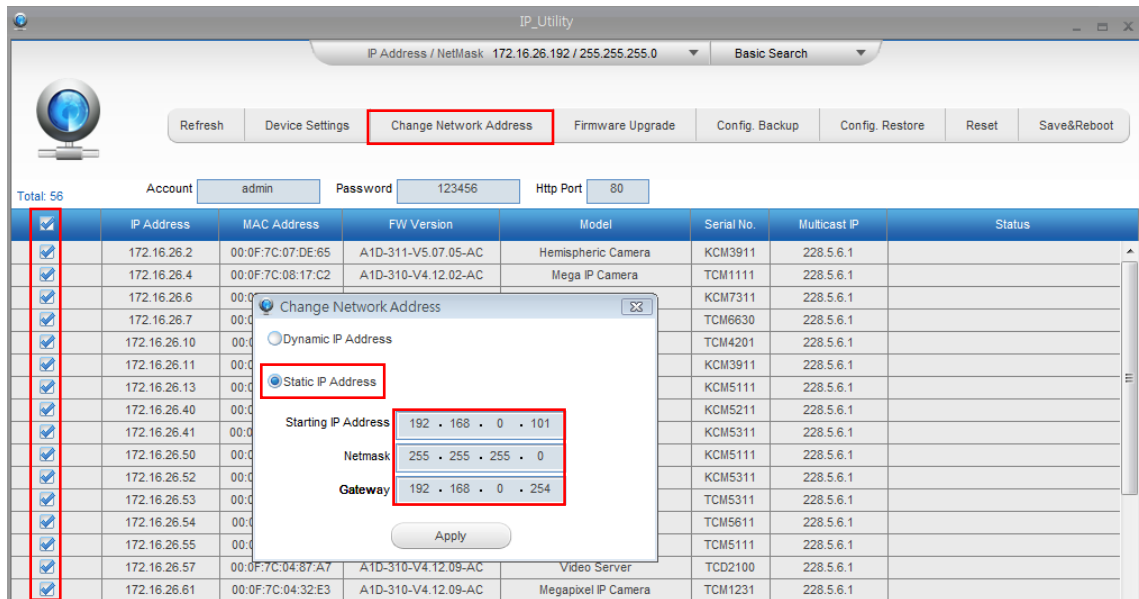

With the procedure shown above, all the cameras will have unique IP addresses, starting from 192.168.0.101. In case there are 20 cameras selected, the last one of the cameras would have the IP 192.168.0.120.

Later, by pressing the “Refresh” button of the IP Utility, you will be able to see the list of cameras with their new IP addresses.

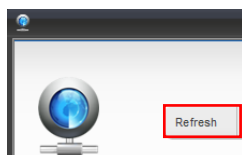

Please note that it is also possible to change the IP addresses manually by using the Web browser. In such case, please plug in only one camera at a time, and change its IP address by using the Web browser before plugging in the next one. This way, the Web browser will not be confused about two devices having the same IP address at the same time.

Access the Camera

Now that the camera and the PC both have their unique IP addresses and are under the same network segment, you can use **Microsoft Internet Explorer** on the PC to access the camera.

Note: Only Microsoft Internet Explorer is supported by the camera at the time of writing this documentation. Please refer to our website (www.acti.com) for future upgrades.

Internet Explorer supports the following functionalities:

Functionality	Internet Explorer
Live Video	Yes
Live Video Area Resizable	Yes
PTZ Control	Yes
Capture the snapshot	Yes
Video overlay based configuration (Motion Detection regions, Privacy Mask regions)	Yes
All the other configurations	Yes

The ActiveX control for video stream management will be downloaded from the camera directly – the user has to accept the use of such control when prompted so. No other third party utilities are required to be installed in such case.

Assuming that the camera's IP address is **192.168.0.100**, you can access it by opening the Web browser and typing the following address into the Web browser's address bar:

`http://192.168.0.100`

Upon successful connection to the camera, the user interface called **Web Configurator** would appear together with the login page. The HTTP port number was not added behind the IP address since the default HTTP port of the camera is 80, which can be omitted from the address for convenience.

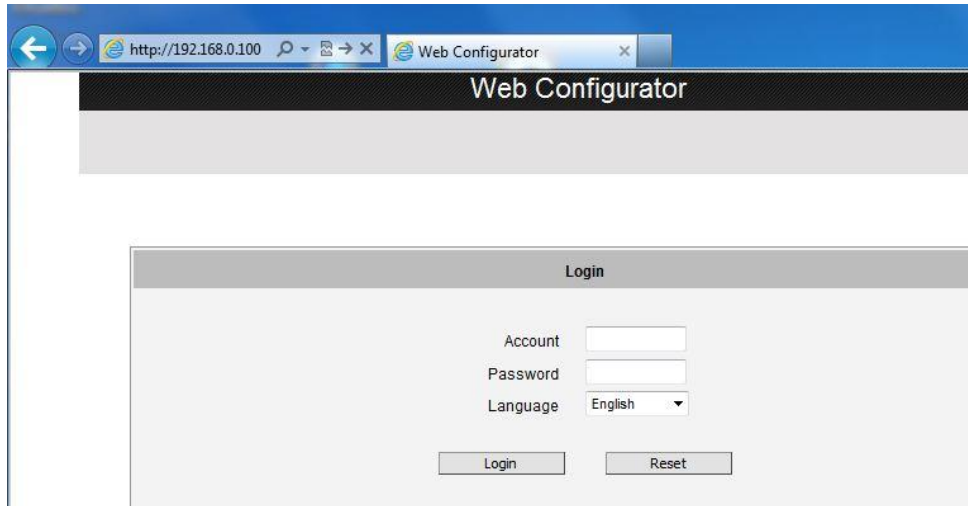

Before logging in, you need to know the factory default Account and Password of the camera.

Account: **Admin**

Password: **123456**

For further operations, please refer to the **Firmware User Manual**.